

## SOD-323 Plastic-Encapsulate Diodes

### B0520WS/B0530WS/B0540WS



#### SCHOTTKY BARRIER DIODE

#### FEATURES

- Low Forward Voltage Drop
- Guard Ring Construction for Transient Protection
- High Conductance
- Also Available in Lead Free Version

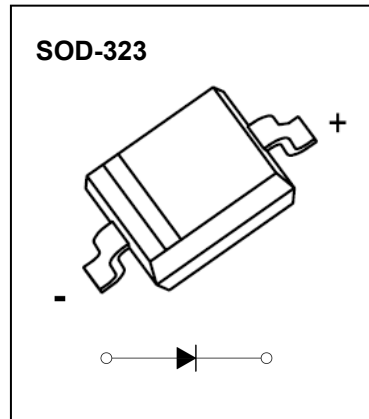
#### MARKING:

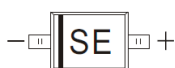
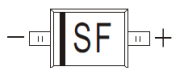
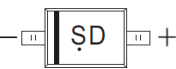
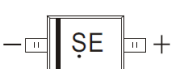

B0520WS:SD	B0530WS:SE	B0540WS:SF
		
		

The marking bar indicates the cathode  
Solid dot = Green molding compound device, if none, the normal device.

#### Maximum Ratings @Ta=25°C

Parameter	Symbol	B0520WS	B0530WS	B0540WS	Unit
Peak repetitive peak reverse voltage	$V_{RRM}$				
Working peak reverse voltage	$V_{RWM}$	20	30	40	V
DC blocking voltage	$V_R$				
RMS reverse voltage reverse voltage (DC)	$V_{R(RMS)}$	14	21	28	V
Average rectified output current	$I_o$		0.5		A
Non-repetitive Peak Forward Surge Current @t=8.3ms	$I_{FSM}$		5.5		A
Power dissipation	$P_D$		200		mW
Thermal resistance junction to ambient	$R_{\theta JA}$		500		°C/W
Junction temperature	$T_j$		125		°C
Storage temperature	$T_{STG}$		-55~+150		°C
Voltage rate of change	$dv/dt$		1000		V/ $\mu$ s

#### Electrical Characteristics @Ta=25°C

Parameter Sy	mbol	B0520WS	B0530WS	B0540WS	Unit	Conditions
Minimum reverse b-reardown voltage	$V_{(BR)}$	20	--	--	V	$I_R=250\mu A$
		--	30	--		$I_R=500\mu A$
		--	--	40		$I_R=20\mu A$
Forward voltage	$V_{F1}$	0.33	0.36	--	V	$I_F=0.1A$
	$V_{F2}$	0.39	0.45	0.510		$I_F=0.5A$
	$V_{F3}$	--	--	0.62		$I_F=1A$
Reverse current	$I_{R1}$	75	--	--	$\mu A$	$V_R=10V$
	$I_{R2}$	--	80	--		$V_R=15V$
Reverse current	$I_{R3}$	250	100	10	$\mu A$	$V_R=20V$
	$I_{R4}$	--	500	--		$V_R=30V$
	$I_{R5}$	--	--	20		$V_R=40V$
Capacitance between terminals	$C_T$	170	170	170	pF	$V_R=0, f=1MHz$

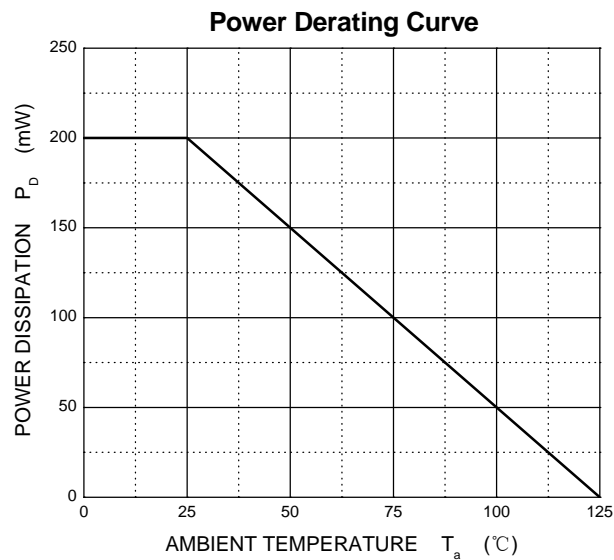
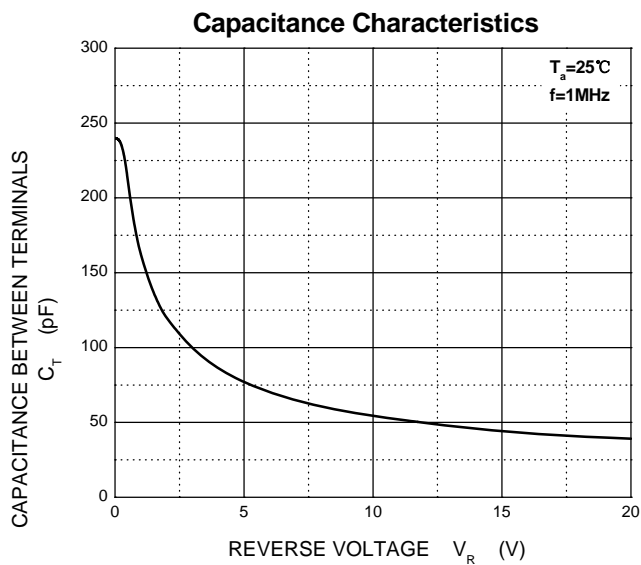
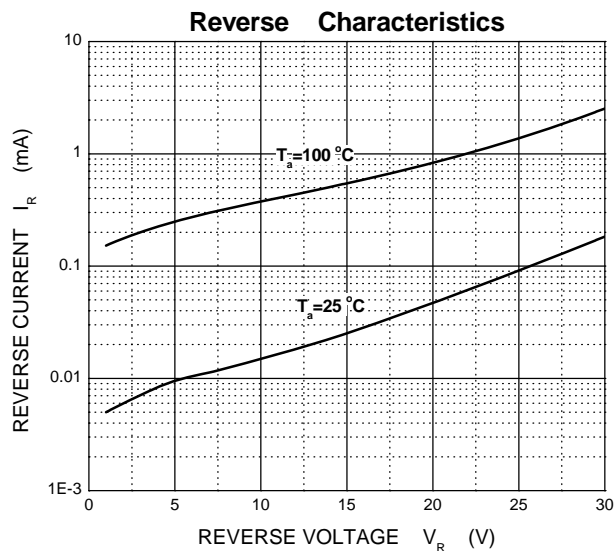
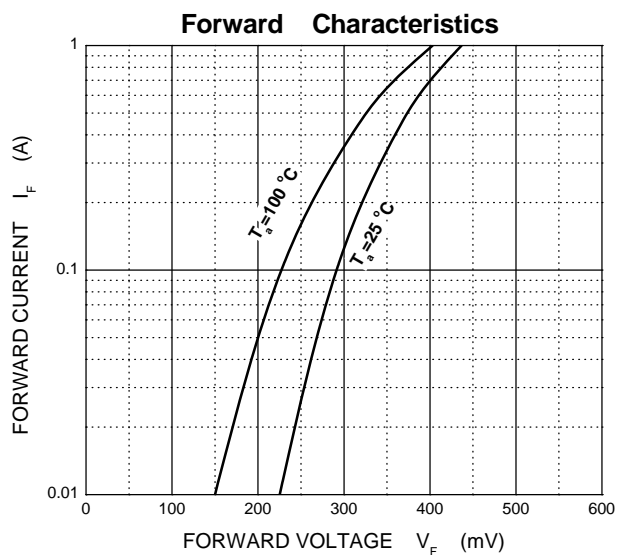

## SOD-323 Package Outline Dimensions

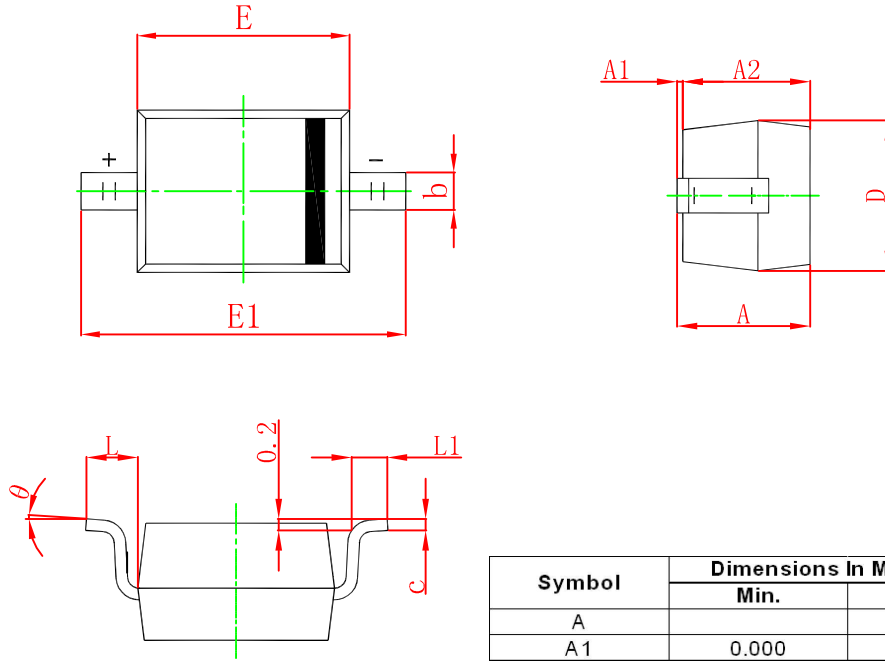

Symbol	Dimensions In Millimeters		Dimensions In Inches	
	Min.	Max.	Min.	Max.
A		1.000		0.039
A1	0.000	0.100	0.000	0.004
A2	0.800	0.900	0.031	0.035
b	0.250	0.350	0.010	0.014
c	0.080	0.150	0.003	0.006
D	1.200	1.400	0.047	0.055
E	1.600	1.800	0.063	0.071
E1	2.550	2.750	0.100	0.108
L	0.475 REF.		0.019 REF.	
L1	0.250	0.400	0.010	0.016
θ	0°	8°	0°	8°

## SOD-323 Suggested Pad Layout

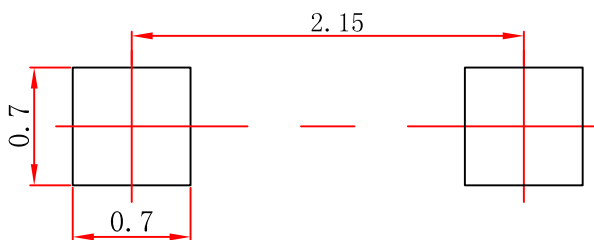

### Note:

1. Controlling dimension: in millimeters.
2. General tolerance:  $\pm 0.05\text{mm}$ .
3. The pad layout is for reference purposes only.

### NOTICE

JCET reserve the right to make modifications, enhancements, improvements, corrections or other changes without further notice to any product herein. JCET does not assume any liability arising out of the application or use of any product described herein.

# SOD-323 Tape and Reel

## SOD-323 Embossed Carrier Tape

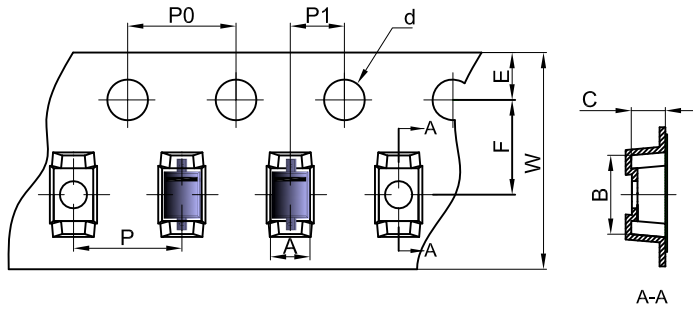

### Packaging Description:

SOD-323 parts are shipped in tape. The carrier tape is made from a dissipative (carbon filled) polycarbonate resin. The cover tape is a multilayer film (Heat Activated Adhesive in nature) primarily composed of polyester film, adhesive layer, sealant, and anti-static sprayed agent. These reeled parts in standard option are shipped with 3,000 units per 7" or 17.8cm diameter reel. The reels are clear in color and is made of polystyrene plastic (anti-static coated).

Dimensions are in millimeter										
Pkg type	A	B	C	d	E	F	P0	P	P1	W
SOD-323	1.48	3.3	1.25	Ø1.50	1.75	3.50	4.00	4.00	2.00	8.00

## SOD-323 Tape Leader and Trailer

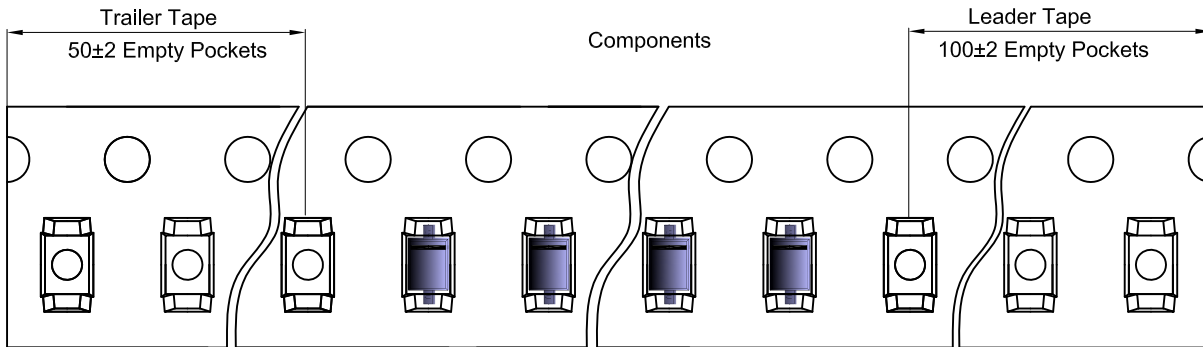

## SOD-323 Reel

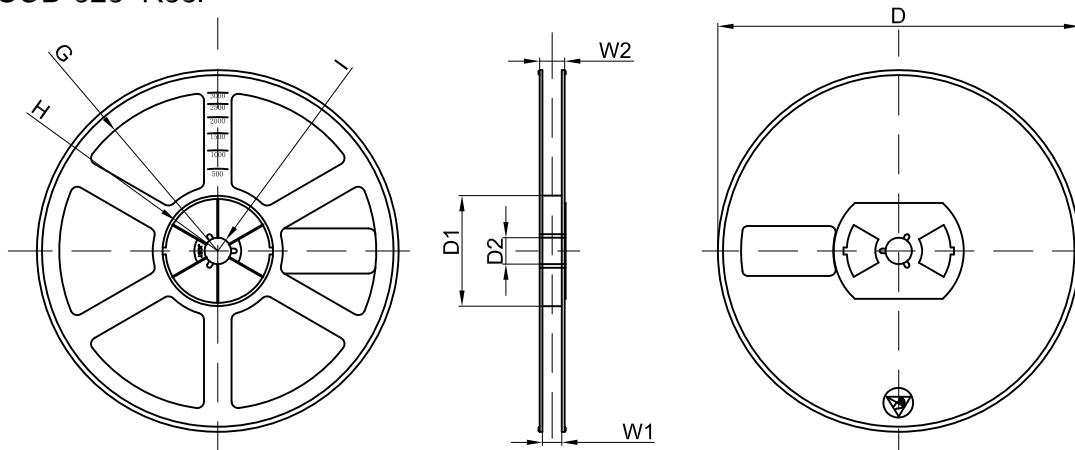

Dimensions are in millimeter								
Reel Option	D	D1	D2	G	H	I	W1	W2
7" Dia	Ø178.00	54.40	13.00	R78.00	R25.60	R6.50	9.50	12.30

REEL	Reel Size	Box	Box Size(mm)	Carton	Carton Size(mm)	G.W.(kg)
3000 pcs	7 inch	45,000 pcs	203×203×195	180,000 pcs	438×438×220	